

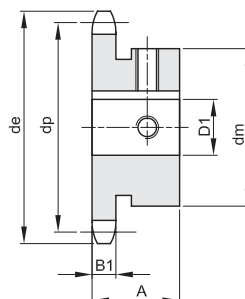

PIÑONES "SYSTEM BEA" PARA CADENAS - DIN 8187 - ISO 606

SPROCKETS FOR ROLLER CHAINS "SYSTEM BEA"

3/8" x 7/32"
9,525 x 5,72 mm
 Rodillo 6,35 mm
06B-1

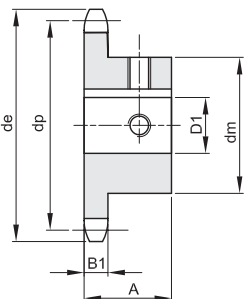
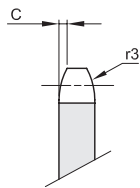

B1	C	r3
5,3	1	10

Material C 43 UNI 7847 - TIPO ^ ejecutado con chavetero y prisionero a 90°

Z	de	dp	dm	D1	A	Kg.	Z	de	dp	dm	D1	A	Kg.
10	34,5	30,82	24*	10^	20	0,06	16	52,5	48,82	37	22	28	0,18
10	34,5	30,82	26*	12	20	0,07	16	52,5	48,82	42*	24	28	0,21
10	34,5	30,82	29*	14	20	0,07	16	52,5	48,82	42*	25	28	0,20
11	37,5	33,80	24*	10^	25	0,09	17	55,5	51,83	40	12	28	0,28
11	37,5	33,80	26*	12	25	0,09	17	55,5	51,83	40	14	28	0,28
11	37,5	33,80	29*	14	25	0,10	17	55,5	51,83	40	15	28	0,27
11	37,5	33,80	30*	15	25	0,10	17	55,5	51,83	40	16	28	0,26
11	37,5	33,80	31*	16	25	0,11	17	55,5	51,83	40	18	28	0,25
12	40,5	36,80	25	10^	25	0,10	17	55,5	51,83	40	19	28	0,24
12	40,5	36,80	26*	12	25	0,10	17	55,5	51,83	40	20	28	0,24
12	40,5	36,80	29*	14	25	0,11	17	55,5	51,83	40	22	28	0,23
12	40,5	36,80	30*	15	25	0,11	17	55,5	51,83	40	22	28	0,23
12	40,5	36,80	31*	16	25	0,11	17	55,5	51,83	40	24	28	0,26
12	40,5	36,80	31*	16	25	0,11	17	55,5	51,83	40	25	28	0,26
13	43,5	39,80	28	10^	25	0,13	18	58,6	54,85	40	12	28	0,30
13	43,5	39,80	28	12	25	0,12	18	58,6	54,85	40	14	28	0,28
13	43,5	39,80	28	14	25	0,11	18	58,6	54,85	43	15	28	0,31
13	43,5	39,80	28	15	25	0,11	18	58,6	54,85	43	16	28	0,31
13	43,5	39,80	31*	16	25	0,12	18	58,6	54,85	43	18	28	0,29
13	43,5	39,80	34*	18	25	0,13	18	58,6	54,85	43	18	28	0,29
13	43,5	39,80	34*	18	25	0,13	18	58,6	54,85	43	19	28	0,29
14	46,5	42,80	31	10^	25	0,16	18	58,6	54,85	43	20	28	0,28
14	46,5	42,80	31	12	25	0,15	18	58,6	54,85	43	22	28	0,27
14	46,5	42,80	31	14	25	0,17	18	58,6	54,85	43	24	28	0,25
14	46,5	42,80	31	15	25	0,14	18	58,6	54,85	43	24	28	0,24
14	46,5	42,80	31	16	25	0,13	19	61,6	57,87	40	12	28	0,31
14	46,5	42,80	31	18	25	0,12	19	61,6	57,87	40	14	28	0,30
14	46,5	42,80	35*	19	25	0,14	19	61,6	57,87	45	15	28	0,35
15	49,5	45,81	34	12	25	0,18	19	61,6	57,87	45	16	28	0,35
15	49,5	45,81	34	14	25	0,18	19	61,6	57,87	45	18	28	0,33
15	49,5	45,81	34	15	25	0,17	19	61,6	57,87	45	19	28	0,33
15	49,5	45,81	34	16	25	0,17	19	61,6	57,87	45	20	28	0,32
15	49,5	45,81	34	18	25	0,15	19	61,6	57,87	45	22	28	0,31
15	49,5	45,81	34	19	25	0,15	19	61,6	57,87	45	24	28	0,29
15	49,5	45,81	34	20	25	0,14	19	61,6	57,87	45	25	28	0,28
15	49,5	45,81	42*	22	25	0,19	20	64,6	60,89	40	12	28	0,32
15	49,5	45,81	42*	24	25	0,17	20	64,6	60,89	40	14	28	0,31
15	49,5	45,81	42*	25	25	0,16	20	64,6	60,89	46	15	28	0,38
16	52,5	48,82	37	12	28	0,24	20	64,6	60,89	46	16	28	0,37
16	52,5	48,82	37	14	28	0,23	20	64,6	60,89	46	18	28	0,36
16	52,5	48,82	37	15	28	0,23	20	64,6	60,89	46	19	28	0,35
16	52,5	48,82	37	16	28	0,22	20	64,6	60,89	46	20	28	0,34
16	52,5	48,82	37	18	28	0,21	20	64,6	60,89	46	22	28	0,33
16	52,5	48,82	37	19	28	0,20	20	64,6	60,89	46	24	28	0,31
16	52,5	48,82	37	20	28	0,20	20	64,6	60,89	46	25	28	0,30



PIÑONES "SYSTEM BEA" PARA CADENAS - DIN 8187 - ISO 606

SPROCKETS FOR ROLLER CHAINS "SYSTEM BEA"

1/2" x 5/16"
12,7 x 7,75 mm
Rodillo 8,51 mm
08B-1

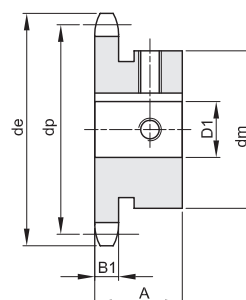
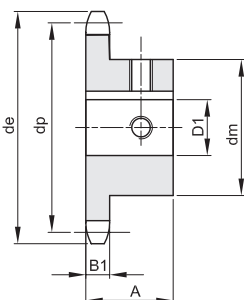
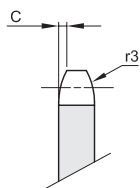

TIPO *

Material C 43 UNI 7847

Z	de	dp	dm	D1	A	Kg.	Z	de	dp	dm	D1	A	Kg.
10	45,9	41,10	26	12	25	0,12	15	65,9	61,09	45	15	28	0,37
10	45,9	41,10	26	14	25	0,11	15	65,9	61,09	45	16	28	0,37
10	45,9	41,10	31*	15	25	0,12	15	65,9	61,09	45	18	28	0,36
10	45,9	41,10	31*	16	25	0,12	15	65,9	61,09	45	19	28	0,35
11	49,9	45,07	29	12	25	0,15	15	65,9	61,09	45	20	28	0,34
11	49,9	45,07	29	14	25	0,14	15	65,9	61,09	45	22	28	0,32
11	49,9	45,07	31*	15	25	0,14	15	65,9	61,09	45	24	28	0,31
11	49,9	45,07	31*	16	25	0,14	15	65,9	61,09	45	25	28	0,30
11	49,9	45,07	37*	18	25	0,16	15	65,9	61,09	45	28	28	0,27
11	49,9	45,07	37*	19	25	0,16	15	65,9	61,09	52*	30	28	0,32
12	53,9	49,07	33	12	28	0,21	15	65,9	61,09	52*	32	28	0,30
12	53,9	49,07	33	14	28	0,20	16	69,9	65,10	50	15	28	0,47
12	53,9	49,07	33	16	28	0,19	16	69,9	65,10	50	16	28	0,46
12	53,9	49,07	33	18	28	0,18	16	69,9	65,10	50	18	28	0,44
12	53,9	49,07	33	19	28	0,17	16	69,9	65,10	50	19	28	0,43
12	53,9	49,07	33	20	28	0,17	16	69,9	65,10	50	20	28	0,43
12	53,9	49,07	40*	22	28	0,20	16	69,9	65,10	50	22	28	0,40
12	53,9	49,07	41*	24	28	0,19	16	69,9	65,10	50	24	28	0,39
12	53,9	49,07	42*	25	28	0,19	16	69,9	65,10	50	25	28	0,38
13	57,9	56,06	37	12	28	0,27	16	69,9	65,10	50	28	28	0,35
13	57,9	56,06	37	14	28	0,26	16	69,9	65,10	50	30	28	0,34
13	57,9	56,06	37	15	28	0,26	16	69,9	65,10	57*	32	28	0,40
13	57,9	56,06	37	16	28	0,25	17	74,0	69,11	52	15	28	0,51
13	57,9	56,06	37	18	28	0,24	17	74,0	69,11	52	16	28	0,51
13	57,9	56,06	37	19	28	0,23	17	74,0	69,11	52	18	28	0,49
13	57,9	56,06	37	20	28	0,22	17	74,0	69,11	52	19	28	0,48
13	57,9	56,06	37	22	28	0,21	17	74,0	69,11	52	20	28	0,47
13	57,9	56,06	42*	24	28	0,22	17	74,0	69,11	52	22	28	0,45
13	57,9	56,06	42*	25	28	0,21	17	74,0	69,11	52	24	28	0,44
13	57,9	56,06	45*	28	28	0,21	17	74,0	69,11	52	25	28	0,43
14	61,9	57,07	33	12	28	0,32	17	74,0	69,11	52	28	28	0,40
14	61,9	57,07	33	14	28	0,31	17	74,0	69,11	52	30	28	0,39
14	61,9	57,07	41	15	28	0,31	17	74,0	69,11	52	32	28	0,38
14	61,9	57,07	41	16	28	0,30	18	78,0	73,14	52	16	28	0,53
14	61,9	57,07	41	18	28	0,29	18	78,0	73,14	52	18	28	0,51
14	61,9	57,07	41	19	28	0,28	18	78,0	73,14	52	19	28	0,50
14	61,9	57,07	41	20	28	0,28	18	78,0	73,14	56	20	28	0,55
14	61,9	57,07	41	22	28	0,27	18	78,0	73,14	56	22	28	0,53
14	61,9	57,07	41	24	28	0,25	18	78,0	73,14	56	24	28	0,52
14	61,9	57,07	41	25	28	0,24	18	78,0	73,14	56	25	28	0,51
14	61,9	57,07	48*	28	28	0,27	18	78,0	73,14	56	28	28	0,48
15	65,9	61,09	33	12	28	0,37	18	78,0	73,14	56	30	28	0,46
15	65,9	61,09	33	14	28	0,36	18	78,0	73,14	56	32	28	0,43



PIÑONES "SYSTEM BEA" PARA CADENAS - DIN 8187 - ISO 606

SPROCKETS FOR ROLLER CHAINS "SYSTEM BEA"

1/2" x 5/16"
12,7 x 7,75 mm
Rodillo 8,51 mm
08B-1

B1	C	r3
7,2	1,3	13

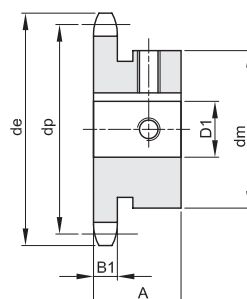
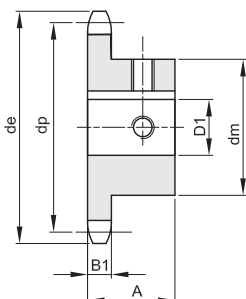
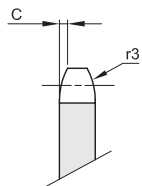

TIPO *

Material C 43 UNI 7847

Z	de	dp	dm	D1	A	Kg.	Z	de	dp	dm	D1	A	Kg.
18	78,0	73,14	56	35	28	0,41	22	94,1	89,24	70	24	28	0,87
18	78,0	73,14	56	38	28	0,39	22	94,1	89,24	70	25	28	0,86
19	82,0	77,16	52	16	28	0,55	22	94,1	89,24	70	28	28	0,83
19	82,0	77,16	52	18	28	0,53	22	94,1	89,24	70	30	28	0,81
19	82,0	77,16	52	19	28	0,52	22	94,1	89,24	70	32	28	0,78
19	82,0	77,16	60	20	28	0,64	22	94,1	89,24	70	35	28	0,75
19	82,0	77,16	60	22	28	0,62	22	94,1	89,24	70	38	28	0,71
19	82,0	77,16	60	24	28	0,60	23	98,1	93,27	65	19	28	0,86
19	82,0	77,16	60	25	28	0,59	23	98,1	93,27	65	20	28	0,85
19	82,0	77,16	60	28	28	0,57	23	98,1	93,27	70	22	28	0,93
19	82,0	77,16	60	30	28	0,55	23	98,1	93,27	70	24	28	0,90
19	82,0	77,16	60	32	28	0,53	23	98,1	93,27	70	25	28	0,89
19	82,0	77,16	60	35	28	0,49	23	98,1	93,27	70	28	28	0,86
19	82,0	77,16	60	38	28	0,46	23	98,1	93,27	70	30	28	0,84
20	86,0	81,19	55	16	28	0,64	23	98,1	93,27	70	32	28	0,82
20	86,0	81,19	55	18	28	0,61	23	98,1	93,27	70	35	28	0,79
20	86,0	81,19	55	19	28	0,59	23	98,1	93,27	70	38	28	0,76
20	86,0	81,19	64	20	28	0,74	24	102,1	97,29	65	19	28	0,91
20	86,0	81,19	64	22	28	0,72	24	102,1	97,29	65	20	28	0,89
20	86,0	81,19	64	24	28	0,71	24	102,1	97,29	70	22	28	0,92
20	86,0	81,19	64	25	28	0,70	24	102,1	97,29	70	24	28	0,94
20	86,0	81,19	64	28	28	0,67	24	102,1	97,29	70	25	28	0,93
20	86,0	81,19	64	30	28	0,65	24	102,1	97,29	70	28	28	0,90
20	86,0	81,19	64	32	28	0,63	24	102,1	97,29	70	30	28	0,88
20	86,0	81,19	64	35	28	0,61	24	102,1	97,29	70	32	28	0,85
20	86,0	81,19	64	38	28	0,59	24	102,1	97,29	70	35	28	0,82
21	90,1	85,22	55	16	28	0,74	24	102,1	97,29	70	38	28	0,79
21	90,1	85,22	55	18	28	0,72	25	106,2	101,33	65	19	28	0,94
21	90,1	85,22	55	19	28	0,71	25	106,2	101,33	65	20	28	0,92
21	90,1	85,22	60	20	28	0,70	25	106,2	101,33	70	22	28	0,99
21	90,1	85,22	60	22	28	0,68	25	106,2	101,33	70	24	28	0,97
21	90,1	85,22	68	24	28	0,80	25	106,2	101,33	70	25	28	0,97
21	90,1	85,22	68	25	28	0,79	25	106,2	101,33	70	28	28	0,94
21	90,1	85,22	68	28	28	0,77	25	106,2	101,33	70	30	28	0,92
21	90,1	85,22	68	30	28	0,75	25	106,2	101,33	70	32	28	0,90
21	90,1	85,22	68	32	28	0,72	25	106,2	101,33	70	35	28	0,86
21	90,1	85,22	68	35	28	0,69	25	106,2	101,33	70	38	28	0,80
21	90,1	85,22	68	38	28	0,65	30	126,3	121,50	75	25	30	1,31
22	94,1	89,24	55	16	28	0,84	30	126,3	121,50	75	28	30	1,28
22	94,1	89,24	55	18	28	0,81	30	126,3	121,50	80	30	30	1,37
22	94,1	89,24	55	19	28	0,80	30	126,3	121,50	80	32	30	1,34
22	94,1	89,24	65	20	28	0,82	30	126,3	121,50	80	35	30	1,31
22	94,1	89,24	65	22	28	0,80	30	126,3	121,50	80	38	30	1,28



PIÑONES "SYSTEM BEA" PARA CADENAS - DIN 8187 - ISO 606

SPROCKETS FOR ROLLER CHAINS "SYSTEM BEA"

5/8" x 3/8"

15,875 x 9,65 mm
Rodillo 10,16 mm
10B-1

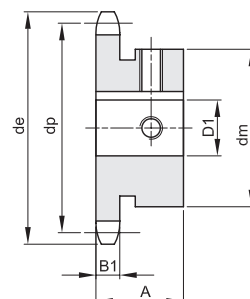
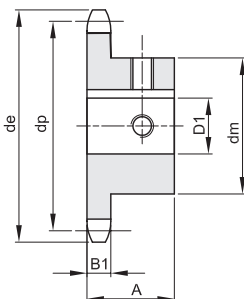
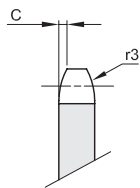

TIPO *

B1	C	r3
9,1	1,6	16

Material C 43 UNI 7847

Z	de	dp	dm	D1	A	Kg.
10	58,3	51,37	35	15	25	0,21
10	58,3	51,37	35	16	25	0,21
10	58,3	51,37	35	18	25	0,20
10	58,3	51,37	35	19	25	0,20
10	58,3	51,37	35	20	25	0,18
10	58,3	51,37	42*	24	25	0,21
11	63,2	56,34	37	15	30	0,30
11	63,2	56,34	37	16	30	0,30
11	63,2	56,34	37	18	30	0,28
11	63,2	56,34	37	19	30	0,27
11	63,2	56,34	37	20	30	0,26
11	63,2	56,34	47*	24	30	0,30
11	63,2	56,34	47*	25	30	0,29
11	63,2	56,34	47*	28	30	0,27
12	68,2	61,34	42	15	30	0,38
12	68,2	61,34	42	16	30	0,37
12	68,2	61,34	42	18	30	0,35
12	68,2	61,34	42	19	30	0,34
12	68,2	61,34	42	20	30	0,34
12	68,2	61,34	42	22	30	0,33
12	68,2	61,34	42	24	30	0,31
12	68,2	61,34	42	25	30	0,30
12	68,2	61,34	51*	28	30	0,34
12	68,2	61,34	51*	30	30	0,32
12	68,2	61,34	55*	32	30	0,34
13	73,2	66,32	47	15	30	0,48
13	73,2	66,32	47	16	30	0,47
13	73,2	66,32	47	18	30	0,45
13	73,2	66,32	47	19	30	0,44
13	73,2	66,32	47	20	30	0,44
13	73,2	66,32	47	22	30	0,42
13	73,2	66,32	47	24	30	0,40
13	73,2	66,32	47	25	30	0,39
13	73,2	66,32	47	28	30	0,36
13	73,2	66,32	47	30	30	0,34
13	73,2	66,32	57*	32	30	0,40
14	78,2	71,34	52	15	30	0,57
14	78,2	71,34	52	16	30	0,56
14	78,2	71,34	52	18	30	0,54
14	78,2	71,34	52	19	30	0,54
14	78,2	71,34	52	20	30	0,53
14	78,2	71,34	52	22	30	0,51
14	78,2	71,34	52	24	30	0,50

Z	de	dp	dm	D1	A	Kg.
14	78,2	71,34	52	25	30	0,49
14	78,2	71,34	52	28	30	0,46
14	78,2	71,34	52	30	30	0,44
14	78,2	71,34	52	32	30	0,42
15	83,2	76,36	57	19	30	0,67
15	83,2	76,36	57	20	30	0,65
15	83,2	76,36	57	22	30	0,63
15	83,2	76,36	57	24	30	0,61
15	83,2	76,36	57	25	30	0,60
15	83,2	76,36	57	28	30	0,57
15	83,2	76,36	57	30	30	0,55
15	83,2	76,36	57	32	30	0,52
15	83,2	76,36	57	35	30	0,49
16	88,3	81,37	60	19	30	0,76
16	88,3	81,37	60	20	30	0,74
16	88,3	81,37	60	22	30	0,73
16	88,3	81,37	60	24	30	0,71
16	88,3	81,37	60	25	30	0,70
16	88,3	81,37	60	28	30	0,68
16	88,3	81,37	60	30	30	0,65
16	88,3	81,37	60	32	30	0,62
16	88,3	81,37	60	35	30	0,58
16	88,3	81,37	60	38	30	0,54
17	93,3	86,39	60	19	30	0,80
17	93,3	86,39	60	20	30	0,78
17	93,3	86,39	60	22	30	0,76
17	93,3	86,39	60	24	30	0,75
17	93,3	86,39	60	25	30	0,74
17	93,3	86,39	60	28	30	0,71
17	93,3	86,39	60	30	30	0,69
17	93,3	86,39	60	32	30	0,65
17	93,3	86,39	60	35	30	0,63
17	93,3	86,39	60	38	30	0,60
18	98,3	91,42	60	19	30	0,85
18	98,3	91,42	60	20	30	0,83
18	98,3	91,42	70	22	30	0,97
18	98,3	91,42	70	24	30	0,96
18	98,3	91,42	70	25	30	0,95
18	98,3	91,42	70	28	30	0,93
18	98,3	91,42	70	30	30	0,91
18	98,3	91,42	70	32	30	0,87
18	98,3	91,42	70	35	30	0,84
18	98,3	91,42	70	38	30	0,80



PIÑONES "SYSTEM BEA" PARA CADENAS - DIN 8187 - ISO 606

SPROCKETS FOR ROLLER CHAINS "SYSTEM BEA"

5/8" x 3/8"

15,875 x 9,65 mm
Rodillo 10,16 mm
10B-1

B1	C	r3
9,1	1,6	16

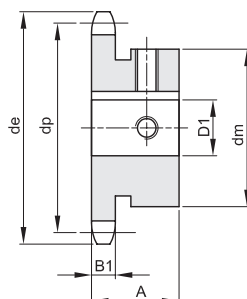
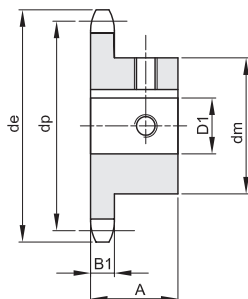
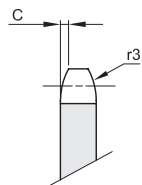

TIPO *

Material C 43 UNI 7847

Z	de	dp	dm	D1	A	Kg.	Z	de	dp	dm	D1	A	Kg.
18	98,3	91,42	70	40	30	0,77	22	118,4	111,55	80	28	30	1,35
18	98,3	91,42	70	42	30	0,74	22	118,4	111,55	80	30	30	1,32
19	103,3	96,45	60	19	30	0,91	22	118,4	111,55	80	32	30	1,29
19	103,3	96,45	60	20	30	0,90	22	118,4	111,55	80	35	30	1,26
19	103,3	96,45	70	22	30	1,07	22	118,4	111,55	80	38	30	1,23
19	103,3	96,45	70	24	30	1,02	22	118,4	111,55	80	40	30	1,19
19	103,3	96,45	70	25	30	1,02	22	118,4	111,55	80	42	30	1,17
19	103,3	96,45	70	28	30	1,00	23	123,5	116,58	65	19	30	1,25
19	103,3	96,45	70	30	30	0,97	23	123,5	116,58	65	20	30	1,22
19	103,3	96,45	70	32	30	0,94	23	123,5	116,58	65	22	30	1,20
19	103,3	96,45	70	35	30	0,91	23	123,5	116,58	70	24	30	1,27
19	103,3	96,45	70	38	30	0,86	23	123,5	116,58	70	25	30	1,25
19	103,3	96,45	70	40	30	0,83	23	123,5	116,58	80	28	30	1,36
19	103,3	96,45	70	42	30	0,80	23	123,5	116,58	80	30	30	1,39
20	108,4	101,49	65	19	30	1,06	23	123,5	116,58	80	32	30	1,36
20	108,4	101,49	65	20	30	1,04	23	123,5	116,58	80	35	30	1,33
20	108,4	101,49	65	22	30	1,01	23	123,5	116,58	80	38	30	1,30
20	108,4	101,49	70	24	30	1,08	23	123,5	116,58	80	40	30	1,26
20	108,4	101,49	70	25	30	1,07	23	123,5	116,58	80	42	30	1,20
20	108,4	101,49	75	28	30	1,13	24	128,5	121,62	65	19	30	1,30
20	108,4	101,49	75	30	30	1,11	24	128,5	121,62	65	20	30	1,28
20	108,4	101,49	75	32	30	1,08	24	128,5	121,62	65	22	30	1,25
20	108,4	101,49	75	35	30	1,05	24	128,5	121,62	70	24	30	1,34
20	108,4	101,49	75	38	30	1,01	24	128,5	121,62	70	25	30	1,33
20	108,4	101,49	75	40	30	0,98	24	128,5	121,62	80	28	30	1,48
20	108,4	101,49	75	42	30	0,95	24	128,5	121,62	80	30	30	1,45
21	113,4	106,52	65	19	30	1,10	24	128,5	121,62	80	32	30	1,42
21	113,4	106,52	65	20	30	1,08	24	128,5	121,62	80	35	30	1,40
21	113,4	106,52	65	22	30	1,06	24	128,5	121,62	80	38	30	1,35
21	113,4	106,52	70	24	30	1,13	24	128,5	121,62	80	40	30	1,33
21	113,4	106,52	70	25	30	1,12	24	128,5	121,62	80	42	30	1,30
21	113,4	106,52	75	28	30	1,15	25	133,6	126,66	65	19	30	1,37
21	113,4	106,52	75	30	30	1,17	25	133,6	126,66	65	20	30	1,35
21	113,4	106,52	75	32	30	1,14	25	133,6	126,66	65	22	30	1,32
21	113,4	106,52	75	35	30	1,11	25	133,6	126,66	70	24	30	1,41
21	113,4	106,52	75	38	30	1,08	25	133,6	126,66	70	25	30	1,39
21	113,4	106,52	75	40	30	1,03	25	133,6	126,66	80	28	30	1,56
21	113,4	106,52	75	42	30	0,99	25	133,6	126,66	80	30	30	1,53
22	118,4	111,55	65	19	30	1,16	25	133,6	126,66	80	32	30	1,50
22	118,4	111,55	65	20	30	1,14	25	133,6	126,66	80	35	30	1,47
22	118,4	111,55	65	22	30	1,11	25	133,6	126,66	80	38	30	1,43
22	118,4	111,55	70	24	30	1,20	25	133,6	126,66	80	40	30	1,40
22	118,4	111,55	70	25	30	1,19	25	133,6	126,66	80	42	30	1,38



PIÑONES "SYSTEM BEA" PARA CADENAS - DIN 8187 - ISO 606

SPROCKETS FOR ROLLER CHAINS "SYSTEM BEA"

3/4" x 7/16"

19,05 x 11,68 mm
Rodillo 12,07 mm
12B-1

B1	C	r3
11,1	2	19

Material C 43 UNI 7847

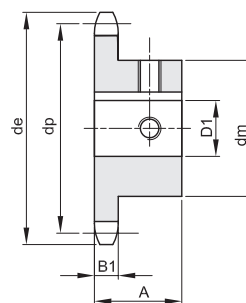
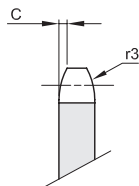

Z	de	dp	dm	D1	A	Kg.	Z	de	dp	dm	D1	A	Kg.
10	69,8	61,64	42	19	30	0,37	15	99,8	91,63	70	28	35	1,09
10	69,8	61,64	42	20	30	0,36	15	99,8	91,63	70	30	35	1,06
10	69,8	61,64	42	24	30	0,33	15	99,8	91,63	70	32	35	1,03
10	69,8	61,64	42	25	30	0,32	15	99,8	91,63	70	35	35	0,99
11	75,8	67,61	46	19	35	0,51	15	99,8	91,63	70	38	35	0,95
11	75,8	67,61	46	20	35	0,50	15	99,8	91,63	70	40	35	0,91
11	75,8	67,61	46	24	35	0,46	16	105,8	97,65	65	19	35	1,17
11	75,8	67,61	46	25	35	0,45	16	105,8	97,65	65	20	35	1,15
12	81,8	73,60	52	19	35	0,67	16	105,8	97,65	65	22	35	1,12
12	81,8	73,60	52	20	35	0,66	16	105,8	97,65	70	24	35	1,22
12	81,8	73,60	52	22	35	0,64	16	105,8	97,65	70	25	35	1,20
12	81,8	73,60	52	24	35	0,61	16	105,8	97,65	75	28	35	1,30
12	81,8	73,60	52	25	35	0,60	16	105,8	97,65	75	30	35	1,25
12	81,8	73,60	52	28	35	0,57	16	105,8	97,65	75	32	35	1,20
12	81,8	73,60	52	30	35	0,55	16	105,8	97,65	75	35	35	1,16
12	81,8	73,60	56	32	35	0,59	16	105,8	97,65	75	38	35	1,12
12	81,8	73,60	56	35	35	0,54	16	105,8	97,65	75	40	35	1,08
13	87,8	79,59	58	19	35	0,82	17	111,9	103,67	70	25	35	1,28
13	87,8	79,59	58	20	35	0,81	17	111,9	103,67	80	28	35	1,35
13	87,8	79,59	58	22	35	0,80	17	111,9	103,67	80	30	35	1,43
13	87,8	79,59	58	24	35	0,77	17	111,9	103,67	80	32	35	1,40
13	87,8	79,59	58	25	35	0,76	17	111,9	103,67	80	35	35	1,37
13	87,8	79,59	58	28	35	0,73	17	111,9	103,67	80	38	35	1,33
13	87,8	79,59	58	30	35	0,70	17	111,9	103,67	80	40	35	1,28
13	87,8	79,59	58	32	35	0,66	17	111,9	103,67	80	42	35	1,23
13	87,8	79,59	58	35	35	0,62	18	117,9	109,71	70	25	35	1,37
13	87,8	79,59	61	38	35	0,67	18	117,9	109,71	80	28	35	1,55
14	93,8	85,61	60	19	35	0,92	18	117,9	109,71	80	30	35	1,52
14	93,8	85,61	60	20	35	0,91	18	117,9	109,71	80	32	35	1,49
14	93,8	85,61	60	22	35	0,88	18	117,9	109,71	80	35	35	1,45
14	93,8	85,61	64	24	35	0,94	18	117,9	109,71	80	38	35	1,40
14	93,8	85,61	64	25	35	0,93	18	117,9	109,71	80	40	35	1,36
14	93,8	85,61	64	28	35	0,90	18	117,9	109,71	80	42	35	1,32
14	93,8	85,61	64	30	35	0,87	19	123,9	115,75	70	25	35	1,45
14	93,8	85,61	64	32	35	0,84	19	123,9	115,75	80	28	35	1,65
14	93,8	85,61	64	35	35	0,80	19	123,9	115,75	80	30	35	1,62
14	93,8	85,61	64	38	35	0,75	19	123,9	115,75	80	32	35	1,57
14	93,8	85,61	67	40	35	0,85	19	123,9	115,75	80	35	35	1,53
15	99,8	91,63	65	19	35	1,10	19	123,9	115,75	80	38	35	1,49
15	99,8	91,63	65	20	35	1,08	19	123,9	115,75	80	40	35	1,46
15	99,8	91,63	65	22	35	1,03	19	123,9	115,75	80	42	35	1,42
15	99,8	91,63	70	24	35	1,13	19	123,9	115,75	80	45	35	1,37
15	99,8	91,63	70	25	35	1,11	19	123,9	115,75	80	48	35	1,32



PIÑONES "SYSTEM BEA" PARA CADENAS - DIN 8187 - ISO 606

SPROCKETS FOR ROLLER CHAINS "SYSTEM BEA"

3/4" x 7/16"

19,05 x 11,68 mm
Rodillo 12,07 mm
12B-1

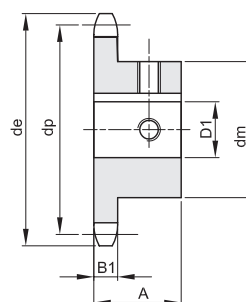
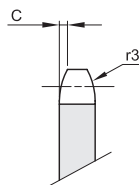

B1	C	r3
11,1	2	19

Material C 43 UNI 7847

Z	de	dp	dm	D1	A	Kg.	Z	de	dp	dm	D1	A	Kg.
19	123,9	115,75	80	50	35	1,25	23	148,1	139,90	90	48	40	2,15
20	130,0	121,78	70	25	35	1,54	23	148,1	139,90	90	50	40	2,10
20	130,0	121,78	80	28	35	1,77	24	154,1	145,94	70	25	40	2,14
20	130,0	121,78	80	30	35	1,72	24	154,1	145,94	80	28	40	2,37
20	130,0	121,78	80	32	35	1,67	24	154,1	145,94	80	30	40	2,32
20	130,0	121,78	80	35	35	1,63	24	154,1	145,94	90	32	40	2,60
20	130,0	121,78	80	38	35	1,58	24	154,1	145,94	90	35	40	2,54
20	130,0	121,78	80	40	35	1,55	24	154,1	145,94	90	38	40	2,49
20	130,0	121,78	80	42	35	1,50	24	154,1	145,94	90	40	40	2,44
20	130,0	121,78	80	45	35	1,45	24	154,1	145,94	90	42	40	2,39
20	130,0	121,78	80	48	35	1,40	24	154,1	145,94	90	45	40	2,34
20	130,0	121,78	80	50	35	1,36	24	154,1	145,94	90	48	40	2,28
21	136,0	127,82	70	25	40	1,78	24	154,1	145,94	90	50	40	2,23
21	136,0	127,82	80	28	40	2,02	25	160,2	152,00	70	25	40	2,25
21	136,0	127,82	80	30	40	1,97	25	160,2	152,00	80	28	40	2,51
21	136,0	127,82	90	32	40	2,23	25	160,2	152,00	80	30	40	2,45
21	136,0	127,82	90	35	40	2,19	25	160,2	152,00	90	32	40	2,71
21	136,0	127,82	90	38	40	2,14	25	160,2	152,00	90	35	40	2,67
21	136,0	127,82	90	40	40	2,09	25	160,2	152,00	90	38	40	2,62
21	136,0	127,82	90	42	40	2,04	25	160,2	152,00	90	40	40	2,58
21	136,0	127,82	90	45	40	1,98	25	160,2	152,00	90	42	40	2,52
21	136,0	127,82	90	48	40	1,93	25	160,2	152,00	90	45	40	2,46
21	136,0	127,82	90	50	40	1,87	25	160,2	152,00	90	48	40	2,41
22	142,0	133,86	70	25	40	1,90	25	160,2	152,00	90	50	40	2,36
22	142,0	133,86	80	28	40	1,16							
22	142,0	133,86	80	30	40	1,10							
22	142,0	133,86	90	32	40	2,37							
22	142,0	133,86	90	35	40	2,31							
22	142,0	133,86	90	38	40	2,26							
22	142,0	133,86	90	40	40	2,21							
22	142,0	133,86	90	42	40	2,18							
22	142,0	133,86	90	45	40	2,13							
22	142,0	133,86	90	48	40	2,06							
22	142,0	133,86	90	50	40	1,99							
23	148,1	139,90	70	25	40	2,02							
23	148,1	139,90	80	28	40	2,28							
23	148,1	139,90	80	30	40	2,21							
23	148,1	139,90	90	32	40	2,47							
23	148,1	139,90	90	35	40	2,41							
23	148,1	139,90	90	38	40	2,36							
23	148,1	139,90	90	40	40	2,32							
23	148,1	139,90	90	42	40	2,27							
23	148,1	139,90	90	45	40	2,21							



PIÑONES "SYSTEM BEA" PARA CADENAS - DIN 8187 - ISO 606

SPROCKETS FOR ROLLER CHAINS "SYSTEM BEA"

1" x 17,02 mm

25,4 x 17,02 mm
Rodillo 15,88 mm
16B-1

B1	C	r3
16,2	2,5	26

Material C 43 UNI 7847

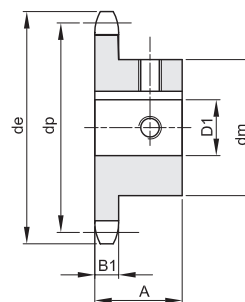
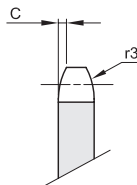

Z	de	dp	dm	D1	A	Kg.	Z	de	dp	dm	D1	A	Kg.
11	101,7	90,14	61	25	40	1,12	15	133,7	122,17	92	38	40	2,25
11	101,7	90,14	61	28	40	1,09	15	133,7	122,17	92	40	40	2,21
11	101,7	90,14	61	30	40	1,06	15	133,7	122,17	92	42	40	2,15
11	101,7	90,14	61	32	40	1,02	15	133,7	122,17	92	45	40	2,08
11	101,7	90,14	61	35	40	0,98	15	133,7	122,17	92	48	40	2,03
11	101,7	90,14	65	38	40	0,97	15	133,7	122,17	92	50	40	1,99
11	101,7	90,14	67	40	40	0,99	16	141,8	130,20	80	25	45	2,59
11	101,7	90,14	67	42	40	0,97	16	141,8	130,20	80	28	45	2,50
12	109,7	98,14	69	25	40	1,42	16	141,8	130,20	80	30	45	2,47
12	109,7	98,14	69	28	40	1,39	16	141,8	130,20	100	32	45	3,09
12	109,7	98,14	69	30	40	1,35	16	141,8	130,20	100	35	45	3,01
12	109,7	98,14	69	32	40	1,31	16	141,8	130,20	100	38	45	2,94
12	109,7	98,14	69	35	40	1,27	16	141,8	130,20	100	40	45	2,89
12	109,7	98,14	69	38	40	1,22	16	141,8	130,20	100	42	45	2,84
12	109,7	98,14	69	40	40	1,17	16	141,8	130,20	100	45	45	2,78
12	109,7	98,14	69	42	40	1,13	16	141,8	130,20	100	48	45	2,70
13	117,7	106,12	70	25	40	1,59	16	141,8	130,20	100	50	45	2,65
13	117,7	106,12	78	28	40	1,61	17	149,8	138,22	80	25	45	2,75
13	117,7	106,12	78	30	40	1,63	17	149,8	138,22	80	28	45	2,70
13	117,7	106,12	78	32	40	1,62	17	149,8	138,22	80	30	45	2,67
13	117,7	106,12	78	35	40	1,61	17	149,8	138,22	100	32	45	3,30
13	117,7	106,12	78	38	40	1,56	17	149,8	138,22	100	35	45	3,21
13	117,7	106,12	78	40	40	1,51	17	149,8	138,22	100	38	45	3,15
13	117,7	106,12	78	42	40	1,48	17	149,8	138,22	100	40	45	3,09
13	117,7	106,12	78	45	40	1,45	17	149,8	138,22	100	42	45	3,02
13	117,7	106,12	78	48	40	1,41	17	149,8	138,22	100	45	45	2,97
13	117,7	106,12	78	50	40	1,37	17	149,8	138,22	100	48	45	2,91
14	125,7	114,15	70	25	40	1,83	17	149,8	138,22	100	50	45	2,84
14	125,7	114,15	80	28	40	1,95	18	157,8	146,28	80	25	45	2,97
14	125,7	114,15	80	30	40	1,92	18	157,8	146,28	80	28	45	2,92
14	125,7	114,15	80	32	40	1,89	18	157,8	146,28	80	30	45	2,89
14	125,7	114,15	84	35	40	1,91	18	157,8	146,28	100	32	45	3,47
14	125,7	114,15	84	38	40	1,86	18	157,8	146,28	100	35	45	3,42
14	125,7	114,15	84	40	40	1,83	18	157,8	146,28	100	38	45	3,37
14	125,7	114,15	84	42	40	1,75	18	157,8	146,28	100	40	45	3,32
14	125,7	114,15	84	45	40	1,71	18	157,8	146,28	100	42	45	3,25
14	125,7	114,15	84	48	40	1,66	18	157,8	146,28	100	45	45	3,19
14	125,7	114,15	84	50	40	1,61	18	157,8	146,28	100	48	45	3,12
15	133,7	122,17	70	25	40	1,94	18	157,8	146,28	100	50	45	3,06
15	133,7	122,17	80	28	40	2,12	19	165,9	154,33	80	25	45	3,21
15	133,7	122,17	80	30	40	2,09	19	165,9	154,33	80	28	45	3,18
15	133,7	122,17	80	32	40	2,03	19	165,9	154,33	80	30	45	3,12
15	133,7	122,17	92	35	40	2,30	19	165,9	154,33	100	32	45	3,71



PIÑONES "SYSTEM BEA" PARA CADENAS - DIN 8187 - ISO 606

SPROCKETS FOR ROLLER CHAINS "SYSTEM BEA"

1" x 17,02 mm

25,4 x 17,02 mm
Rodillo 15,88 mm
16B-1

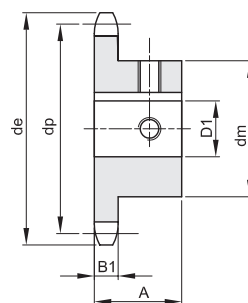
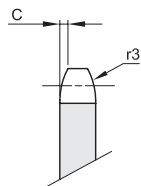

B1	C	r3
16,2	2,5	26

Material C 43 UNI 7847

Z	de	dp	dm	D1	A	Kg.	Z	de	dp	dm	D1	A	Kg.
19	165,9	154,33	100	35	45	3,67	23	198,1	186,53	100	32	50	5,08
19	165,9	154,33	100	38	45	3,61	23	198,1	186,53	100	35	50	5,01
19	165,9	154,33	100	40	45	3,56	23	198,1	186,53	100	38	50	4,93
19	165,9	154,33	100	42	45	3,51	23	198,1	186,53	110	40	50	5,32
19	165,9	154,33	100	45	45	3,46	23	198,1	186,53	110	42	50	5,28
19	165,9	154,33	100	48	45	3,38	23	198,1	186,53	110	45	50	5,22
19	165,9	154,33	100	50	45	3,30	23	198,1	186,53	110	48	50	5,17
20	173,9	162,38	80	25	45	3,46	23	198,1	186,53	110	50	50	5,11
20	173,9	162,38	80	28	45	3,41	24	206,2	194,59	80	25	50	4,79
20	173,9	162,38	80	30	45	3,37	24	206,2	194,59	80	28	50	4,73
20	173,9	162,38	100	32	45	3,95	24	206,2	194,59	80	30	50	4,68
20	173,9	162,38	100	35	45	3,90	24	206,2	194,59	100	32	50	5,37
20	173,9	162,38	100	38	45	3,84	24	206,2	194,59	100	35	50	5,31
20	173,9	162,38	100	40	45	3,79	24	206,2	194,59	100	38	50	5,26
20	173,9	162,38	100	42	45	3,72	24	206,2	194,59	110	40	50	5,63
20	173,9	162,38	100	45	45	3,65	24	206,2	194,59	110	42	50	5,54
20	173,9	162,38	100	48	45	3,60	24	206,2	194,59	110	45	50	5,46
20	173,9	162,38	100	50	45	3,55	24	206,2	194,59	110	48	50	5,39
21	182,0	170,43	80	25	50	3,92	24	206,2	194,59	110	50	50	5,32
21	182,0	170,43	80	28	50	3,86	25	214,2	202,66	80	25	50	5,11
21	182,0	170,43	80	30	50	3,81	25	214,2	202,66	80	28	50	5,04
21	182,0	170,43	100	32	50	4,52	25	214,2	202,66	80	30	50	4,97
21	182,0	170,43	100	35	50	4,45	25	214,2	202,66	100	32	50	5,67
21	182,0	170,43	100	38	50	4,38	25	214,2	202,66	100	35	50	5,60
21	182,0	170,43	110	40	50	4,75	25	214,2	202,66	100	38	50	5,53
21	182,0	170,43	110	42	50	4,70	25	214,2	202,66	110	40	50	5,92
21	182,0	170,43	110	45	50	4,63	25	214,2	202,66	110	42	50	5,84
21	182,0	170,43	110	48	50	4,54	25	214,2	202,66	110	45	50	5,77
21	182,0	170,43	110	50	50	4,48	25	214,2	202,66	110	48	50	5,70
22	190,1	178,48	80	25	50	4,19	25	214,2	202,66	110	50	50	5,64
22	190,1	178,48	80	28	50	4,13							
22	190,1	178,48	80	30	50	4,08							
22	190,1	178,48	100	32	50	4,79							
22	190,1	178,48	100	35	50	4,72							
22	190,1	178,48	100	38	50	4,66							
22	190,1	178,48	110	40	50	5,04							
22	190,1	178,48	110	42	50	5,00							
22	190,1	178,48	110	45	50	4,94							
22	190,1	178,48	110	48	50	4,88							
22	190,1	178,48	110	50	50	4,82							
23	198,1	186,53	80	25	50	4,48							
23	198,1	186,53	80	28	50	4,42							
23	198,1	186,53	80	30	50	4,35							



PIÑONES "SYSTEM BEA" PARA CADENAS - DIN 8187 - ISO 606

SPROCKETS FOR ROLLER CHAINS "SYSTEM BEA"

Templado por induccion en los dientes (HRc 50)
 Diametro ejes en tolleranza H7 - Rugosidad RA 1,6
 Chavetero según DIN 6885 / UNI 6604 alineados al diente
 con 2 prisioneros.

Teeth: inductioned hardness (HRc 50)
 Final bore tolerance H7 - Roughness value RA 1,6
 Keyway to DIN 6885 / BS 4235 is located on the center line of tooth
 Two grub screw holes

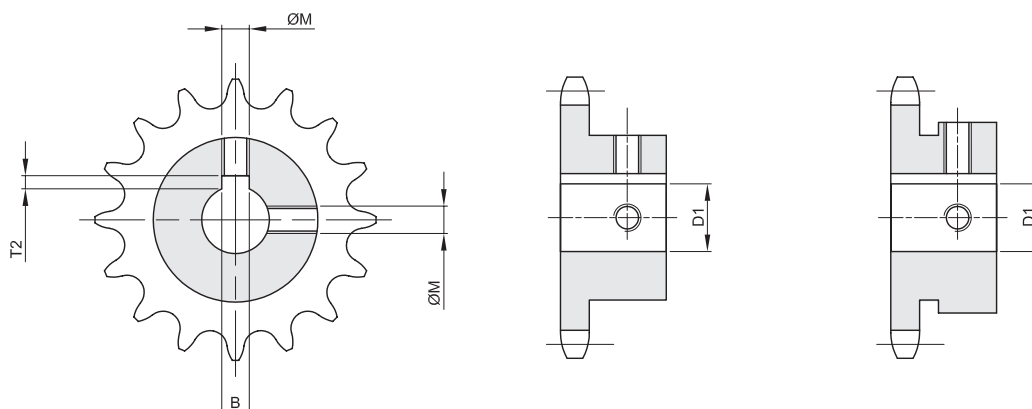

diametro eje D1	altura chavetero B	profundidad chavetero T2	diametro prisioneros Ø M
Ø10 H7 +0,015 -0	3 H9 +0,025 -0	1,4 +0,10 -0	M4
Ø12 H7 +0,018 -0	4 H9 +0,030 -0	1,8 +0,10 -0	M4
Ø14 H7 +0,018 -0	5 H9 +0,030 -0	2,3 +0,10 -0	M4
Ø15 H7 +0,018 -0	5 H9 +0,030 -0	2,3 +0,10 -0	M4
Ø16 H7 +0,018 -0	5 H9 +0,030 -0	2,3 +0,10 -0	M4
Ø18 H7 +0,018 -0	6 H9 +0,030 -0	2,8 +0,10 -0	M5
Ø19 H7 +0,021 -0	6 H9 +0,030 -0	2,8 +0,10 -0	M5
Ø20 H7 +0,021 -0	6 H9 +0,030 -0	2,8 +0,10 -0	M5
Ø22 H7 +0,021 -0	6 H9 +0,030 -0	2,8 +0,10 -0	M5
Ø24 H7 +0,021 -0	8 H9 +0,036 -0	3,3 +0,20 -0	M6
Ø25 H7 +0,021 -0	8 H9 +0,036 -0	3,3 +0,20 -0	M6
Ø28 H7 +0,021 -0	8 H9 +0,036 -0	3,3 +0,20 -0	M6
Ø30 H7 +0,021 -0	8 H9 +0,036 -0	3,3 +0,20 -0	M6
Ø32 H7 +0,025 -0	10 H9 +0,036 -0	3,3 +0,20 -0	M8
Ø35 H7 +0,025 -0	10 H9 +0,036 -0	3,3 +0,20 -0	M8
Ø38 H7 +0,025 -0	10 H9 +0,036 -0	3,3 +0,20 -0	M8
Ø40 H7 +0,025 -0	12 H9 +0,043 -0	3,3 +0,20 -0	M10
Ø42 H7 +0,025 -0	12 H9 +0,043 -0	3,3 +0,20 -0	M10
Ø45 H7 +0,025 -0	14 H9 +0,043 -0	3,8 +0,20 -0	M12
Ø48 H7 +0,025 -0	14 H9 +0,043 -0	3,8 +0,20 -0	M12
Ø50 H7 +0,025 -0	14 H9 +0,043 -0	3,8 +0,20 -0	M12